

Indian Creek Design, Inc.

BKO

2004 Standard Model

Assembly Manual

2004 BKO Assembly Instructions:

Feed Tube and Ball Detent Assembly.....4

2004 BKO Low Pressure Regulator.....5

2004 BKO Valve Assembly.....6

BKO Cylinder Assembly.....7

Bolt Assembly.....8

2004 BKO Regulator Mount.....9

High Pressure Regulator Assembly.....10

Trigger and Grip Assembly.....11

Final Assembly of BKO Upper and Lower Receiver.....14

Testing Instructions.....15

Appendix: Parts List.....16

Introduction:

The BKO Model paintball gun is relatively easy to assemble. You will need the proper tools and equipment, including a vise, red and blue loctite, Dow 33 Clear Lithium Grease, and assorted allen keys and screwdrivers. It is easiest to assemble in relatively the same order as these pages.

Prior to assembly, make sure that all pieces are properly deburred, cleaned, and coated, if required. Seal edges, like those on the regulator cup 982052 and valve seat 982030 must be sanded smooth and have no dents or marks. Nubbins on pieces like the plungers 982053 and 202052 must be trimmed. O-Rings and seals must be smooth, clean, and in good condition.

FEED TUBE AND BALL DETENT ASSEMBLY

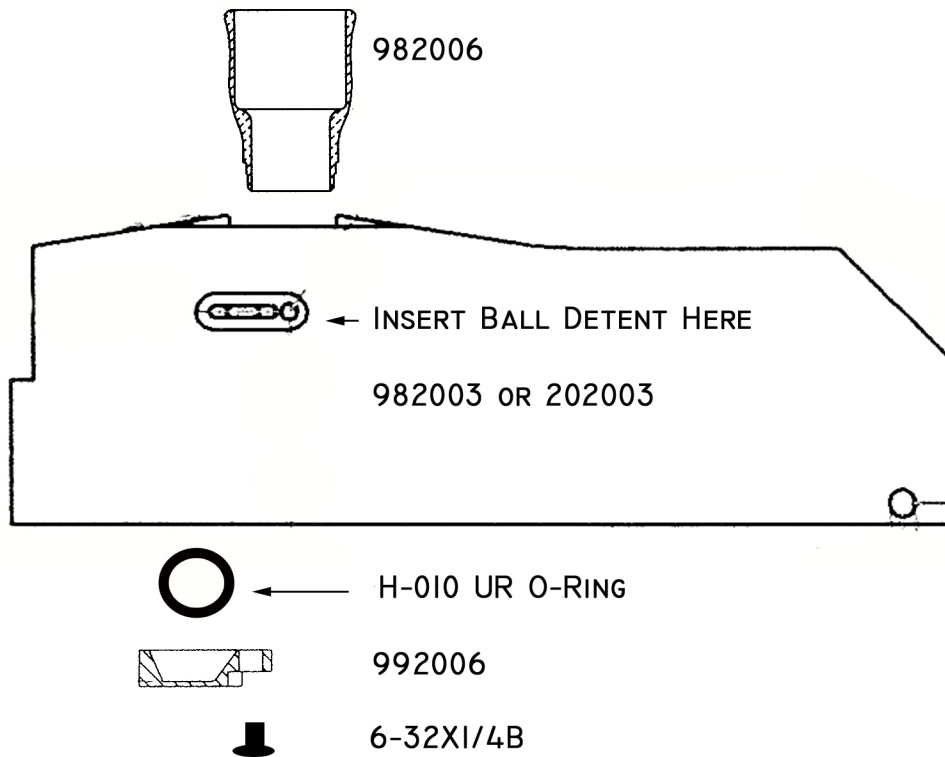

APPLY A SMALL DAB OF RED LOCTITE TO THE THREADS OF FEED TUBE 982006. CAREFULLY SCREW INTO UPPER RECEIVER. TIGHTEN FIRMLY, WITHOUT PUTTING UNBALANCED STRESS ON THE FEED TUBE, WHICH MAY CAUSE IT TO BEND. WIPE OFF ANY EXCESS LOCTITE.

CAREFULLY DROP THE H-010 URETHANE 90 O-RING INTO THE SLOT ON THE SIDE OF THE UPPER RECEIVER. LAY THE BALL DETENT CASING 992006 OVER THE O-RING SO THAT IT HOLDS THE O-RING PROPERLY. SCREW IN THE 6-32X1/4 BUTTONHEAD SCREW.

FOR BKO, THERE IS ONLY ONE BALL DETENT. FOR THE B2K STANDARD MODEL, THERE ARE TWO. REPEAT THE ABOVE PROCESS ON THE OTHER SIDE.

2004 BKO LOW PRESSURE REGULATOR

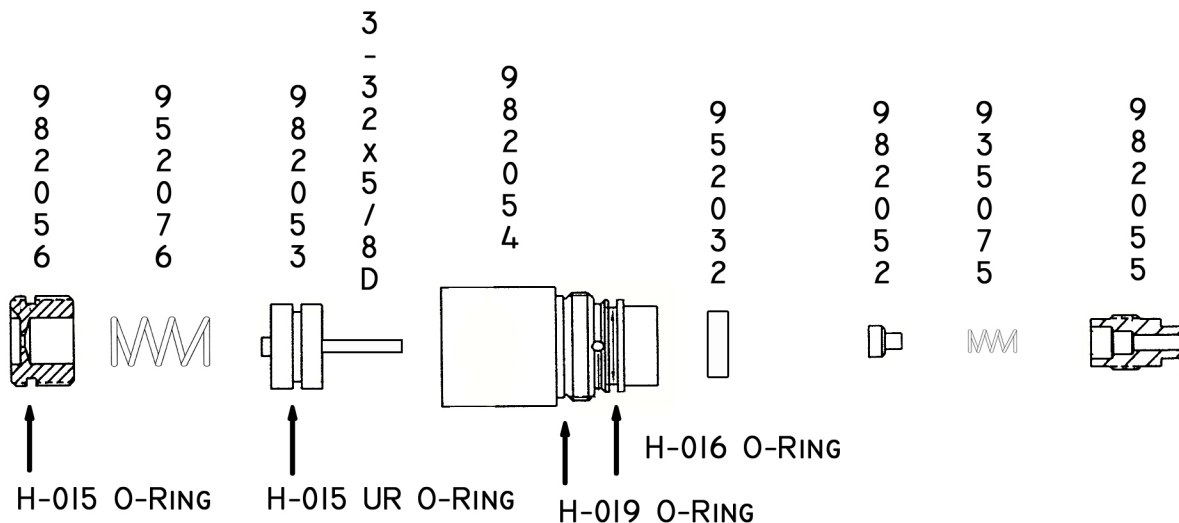

PRESS THE 3-32x5/8 DOWEL PIN INTO THE PLUNGER 982053. MAKE SURE THE PIN IS STRAIGHT AND THE PLUNGER HAS AN OVERALL HEIGHT OF .895 IN. PLACE ALL ORINGS ON DESIGNATED PIECES. IN THE BACK OF BODY 982054, PRESS IN THE SEAL 952032. HOLDING THE CUP HOUSING 982055 WITH THE LARGER BORE UP, INSERT THE SPRING 935075 AND THEN THE REGULATOR CUP 982052 WITH THE CUP PORTION FACING UP. SCREW THE CUP HOUSING 982055 ONTO THE BODY 982054 BY TILTING THE BODY 982054 UPSIDE DOWN. BE CAREFUL NOT TO DISTURB THE CUP 982052. ONCE THE CUP HOUSING 982055 IS HAND-TIGHT, USE A VISE OR PLIERS TO TURN IT AN ADDITIONAL 1/4 TURN. DO NOT OVERTIGHTEN. THIS WILL CAUSE THE REGULATOR TO OVERPRESSURIZE. USE A SMALL ALLEN KEY AND PUSH THROUGH THE OTHER SIDE OF BODY 982054 AND MAKE SURE THE CUP 982052 BOUNCES FREELY UP AND DOWN. LUBRICATE THE PLUNGER 982053 LIBERALLY WITH DOW 33 CLEAR LITHIUM GREASE. LAY THE ADJUSTMENT SCREW 982056 WITH THE HOLE PORTION FACING UP AND THE ADJUSTMENT SIDE FACE DOWN. REST THE SPRING 952076 IN THE ADJUSTMENT SCREW HOLE. PLACE THE PLUNGER 982053 ON TOP OF THE SPRING 952076 WITH THE NUBBIN FACING DOWN AND THE STEEL DOWEL PIN FACING UP. VERY CAREFULLY SLIDE THE BODY 982054 DOWN OVER THE PLUNGER 982053 AND SPRING 952076. CAREFULLY BEGIN SCREWING IN THE ADJUSTMENT SCREW 982056 IN THE FRONT OF BODY 982054 UNTIL IT IS FLUSH. LUBRICATE THE OUTSIDE O-RINGS ON THE BODY 982054 BEFORE SCREWING IT INTO THE UPPER RECEIVER 982003. (SEE THE DIRECTIONS FOR THE B2K VALVE ASSEMBLY).

2004 BKO VALVE ASSEMBLY

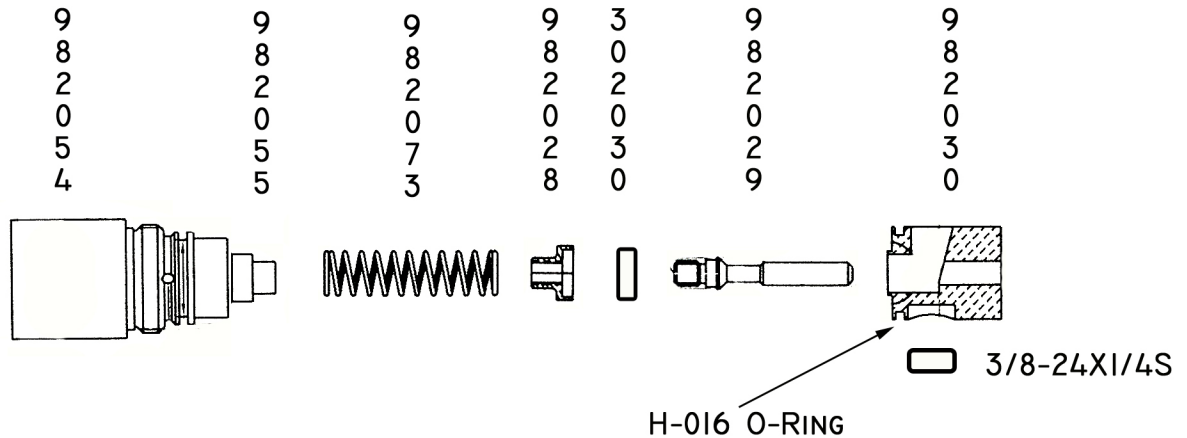

PRESS VALVE SEAL 302030 INTO CUP 982028. APPLY A SMALL DAB OF BLUE LOCTITE TO THE THREADS OF VALVE PIN 982029 AND SCREW VALVE PIN 982029 INTO BRASS CUP 982028 AND SEAL UNTIL THE CHAMFERRED EDGE ON BOTTOM OF PIN 29 MAKES CONTACT WITH SEAL. IT SHOULD BE TIGHT. USE A VISE IF NECESSARY. PLACE O-RINGS ON DESIGNATED PIECES. LUBRICATE THE H-016 O-RING ON SEAT 982030 WITH DOW 33 CLEAR LITHIUM GREASE AND SLIDE SEAT 30 INTO THE FRONT OF BOTTOM BORE OF MAIN BODY 204003 WITH THE LIP SIDE OF SEAT FACING OUT TOWARDS FRONT, THE SCREW MATING PORTION FACING DOWN, AND THE AIR PASSAGE FACING UP. FROM BODY OF UPPER RECEIVER, USE A WRENCH TO ADJUST THE SCREW MATING PORTION PROPERLY SO THAT IT LINES UP CORRECTLY WITH THREADS ON THE BOTTOM OF RECEIVER. APPLY A DAB OF RED LOCTITE TO THE THREADS OF 3/8-24x1/4 SET SCREW AND THREAD INTO PROPER HOLE HAND-TIGHT SO THAT IT HOLDS THE SEAT. DO NOT OVERTIGHTEN. THIS WILL PUSH THE SEAT UP AND THE O-RING WILL NOT SEAL PROPERLY. LUBRICATE STEEL END OF PIN 982029 WITH DOW 33 CLEAR LITHIUM GREASE AND DROP INTO UPPER RECEIVER SO THAT THE STEEL PIN PORTION SLIDES INTO THE SEAT 982030 AND THE CUP AND SEAL PORTION MATES WITH THE LIP ON THE SEAT. ATTACH SPRING 982073 TO THE GUIDE PORTION OF CUP HOUSING 982055. LUBRICATE H-016 O-RING ON REGULATOR BODY 982054 WITH DOW 33 CLEAR LITHIUM GREASE AND SLIDE ENTIRE UNIT INTO BORE OF UPPER RECEIVER SO THAT THE FRONT OF SPRING 982073 SLIDES OVER THE BASE OF VALVE CUP 202028. SCREW IN LP REGULATOR 982054.

2004 BKO CYLINDER ASSEMBLY

202036

APPLY A SMALL DAB OF RED LOCTITE TO THE BRASS 10-32 BARB AND SCREW INTO THE 10-32 THREADED HOLE ON THE FRONT OF THE CYLINDER BODY 202036 TIGHTLY. BE CAREFUL NOT TO GET ANY OF THE LOCTITE IN THE AIR HOLE.

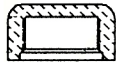
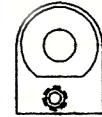

202037



H-010 UR

202033

INSERT SPRING 202071 INTO THE BACK OF CYLINDER BODY 202036. PLACE H-010 URETHANE 90 O-RING ON PISTON 202033. LUBRICATE PISTON 202033 AND O-RING LIBERALLY WITH DOW 33 CLEAR LITHIUM GREASE AND INSERT PISTON 202033 THROUGH THE SPRING AND DOWN INTO CYLINDER BODY 202036 WITH THE O-RING SIDE FACING TOWARDS THE BACK. PLACE THE H-015 O-RING AROUND THE OUTSIDE THREADS OF THE BODY 202036 IN THE BACK. SNUG THE O-RING UP TO THE BASE OF THE BODY 202036. TIGHTEN THE END CAP 202037 DOWN ONTO THE THREADS AND MAKE SURE IT IS TIGHT.



202071

APPLY A SMALL DAB OF RED LOCTITE TO THE THREADS ON THE BOTTOM OF THE PISTON 202033. TIGHTEN THE HAMMER 982032 ONTO THE THREADS. USE A VISE TO ENSURE THAT IT IS TIGHT.

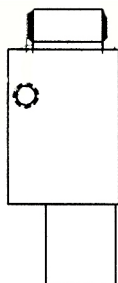

H-015

202036

WHEN PLACING THE CYLINDER IN THE UPPER RECEIVER, SLIDE IN IT THE BACK BOTTOM BORE, HAMMER FIRST. USE TWO 10-32X1/2 BUTTONHEAD SCREWS WITH A SMALL DAB OF BLUE LOCTITE ON THE THREADS AND SCREW INTO THE SIDES OF THE UPPER RECEIVER TO HOLD THE CYLINDER 202036 IN PLACE. ATTACH THE SECOND END OF THE HOSE (WHICH CONNECTS THE REGULATOR MOUNT 204002) TO THE 10-32 BARB.

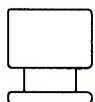

982032

THE LINK PIN 982041 SLIDES THROUGH THE BOLT 982009 AND INTO THE GROOVE OF THE HAMMER 982032. PUSH THE BOLT FORWARD AND WATCH IT SPRING BACK TO ENSURE THAT THE LINK PIN 982041 IS IN THE PROPER PLACE.

BOLT ASSEMBLY

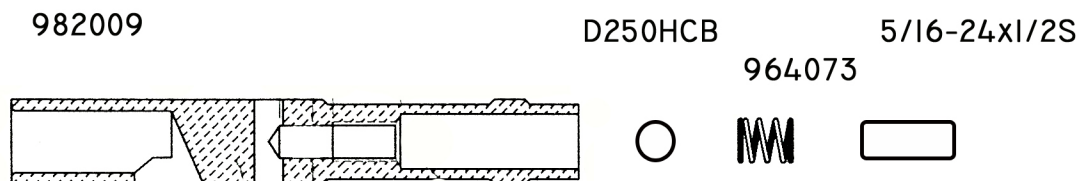

DROP THE D250HCB 1/4 BALL BEARING INTO THE BACK OF THE BOLT 982009. DROP THE SPRING 964073 INTO THE BACK OF 982009. APPLY A SMALL DAB OF RED LOCTITE TO THE THREADS OF THE 5/16-24x1/2 SET SCREW AND SCREW INTO BACK OF BOLT 982009. USE LINK PIN 982041 AND PUSH THROUGH SLOT TO GAUGE THE SPRING TENSION ON THE BACK OF BALL BEARING. ADJUST THE SET SCREW IN UNTIL PRESSURE IS FIRM ENOUGH TO SUFFICIENTLY HOLD LINK PIN 982041 INTO PLACE, BUT LINK PIN CAN STILL BE REMOVED WITHOUT DIFFICULTY. WHEN INSTALLING THE BOLT IN THE UPPER RECEIVER, THE AIR PASSAGE HOLE MUST FACE DOWN AND BE SURE THE LINK PIN 982041 IS POSITION PROPERLY TO BE INSERTED INTO GROOVE OF HAMMER 982032.

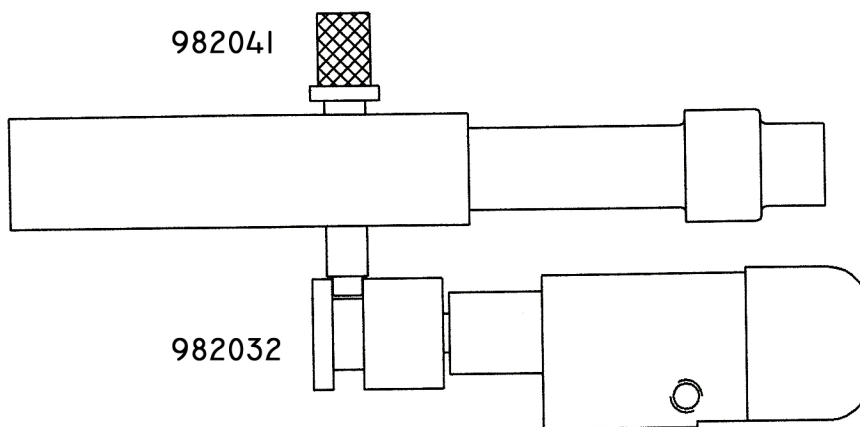

(CYLINDER ASSEMBLY)

2004 BKO REGULATOR MOUNT

204002

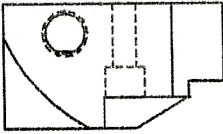

WRAP A LAYER OF TEFLON TAPE AROUND THE THREADS OF THE D700LPG GAUGE. TIGHTEN THE GAUGE INTO THE 1/8 NPT THREADED HOLE ON THE SIDE OF THE REGULATOR MOUNT 202002.

204002

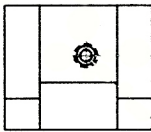

APPLY A SMALL DAB OF RED LOCTITE TO THE THREADS OF THE BRASS 10-32 BARB. GENTLY TIGHTEN IN BARB INTO THE 10-32 THREADED HOLE ON THE BACK OF REGULATOR MOUNT 202002. MAKE SURE NOT TO GET ANY LOCTITE IN THE AIR HOLE.

204002

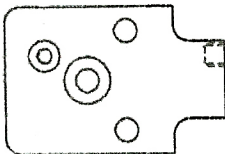

PLACE THE H-006 O-RING IN THE SMALLER GROOVE AND THE H-012 O-RING IN THE LARGER GROOVE. LUBRICATE LIGHTLY WITH DOW 33 CLEAR LITHIUM GREASE.

LINE UP WITH MATCHING HOLES ON THE BOTTOM OF UPPER RECEIVER 204002. SCREW IN THE TWO 10-32X3/4 SOCKET CAP SCREWS.

WHEN THE HIGH PRESSURE REGULATOR IS ASSEMBLED, IT CAN BE SCREWED INTO THE REGULATOR MOUNT.

10-32X3/4S

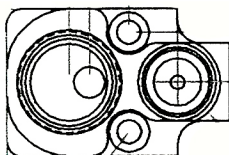
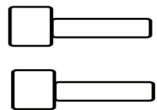

204002

THE HOSE CONNECTS FROM THE 10-32 BARB ON THE BACK OF THE REGULATOR MOUNT 204002 TO THE 10-32 BARB ON THE CYLINDER ASSEMBLY 202036.

HIGH PRESSURE REGULATOR ASSEMBLY

10-32X3/8C

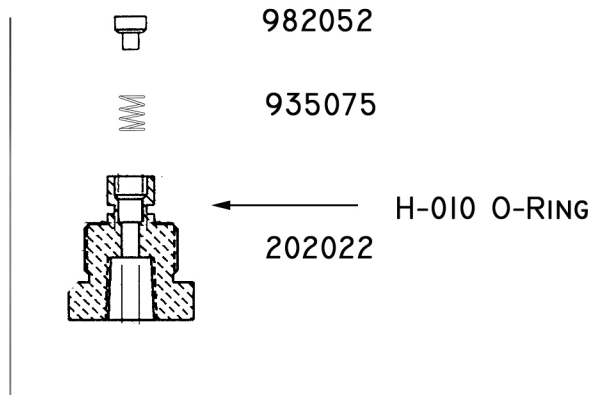
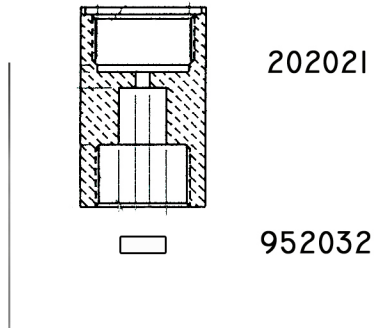
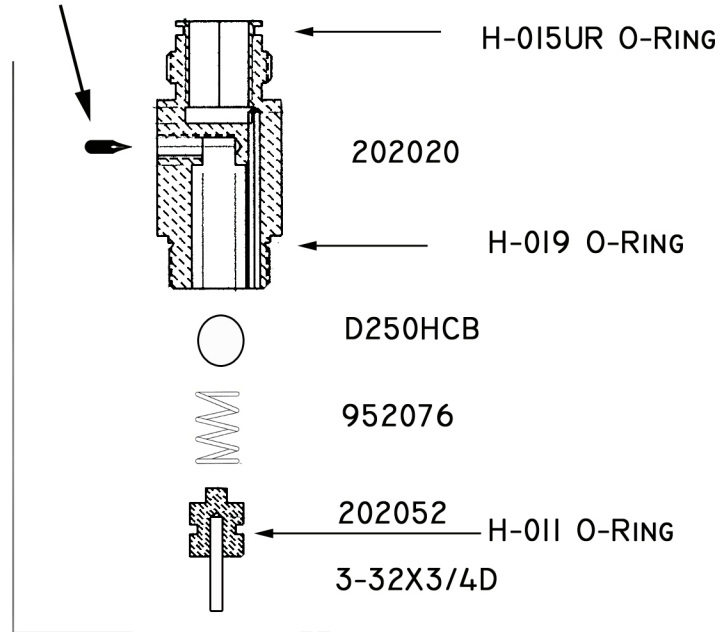

PRESS THE 3/32 DOWEL PIN INTO THE PLUNGER 202052. MAKE SURE THE PIN IS STRAIGHT AND THE PIN HAS AN OVERALL LENGTH OF 0.898 IN. PLACE ALL O-RINGS ON DESIGNATED PIECES. IN PART 202020, SCREW 10-32X3/8C SCREW INTO THE THREADED HOLE ON THE SIDE AND DROP D250HCB INTO BOTTOM, THEN MAIN SPRING 952076. LUBRICATE O-RING ON PLUNGER 202052 LIBERALLY WITH DOW 33 CLEAR LITHIUM GREASE AND PUSH PLUNGER INTO BOTTOM OF 202020, MAKING SURE THAT SPRING UNDERNEATH IS NOT COCKED SIDWAYS. ASSEMBLE 202022 BY CAREFULLY INSERTING SPRING 935075 AND PLACING CUP 982052 ON TOP WITH THE CUP SECTION FACING UP. DROP 952032 INTO PART NUMBER 202021 AND PRESS LIGHTLY INTO PLACE WITH SOMETHING THAT WONT DAMAGE THE SEAL. SCREW 202022 INTO BOTTOM OF 202021, MAKING SURE THAT 202022 DOES NOT TILT TO DISTURB CUP, AND ALSO MAKE SURE THAT 952032 DOES NOT FALL OUT OF 202021. ONCE SCREWED TOGETHER, USE VERY SMALL ALLEN WRENCH AND PUSH DOWN INTO HOLE ON TOP OF 202021 AND MAKE SURE CUP 982052 BOUNCES FREELY UP AND DOWN. THEN SCREW 202020 AND 202021 TOGETHER. TIGHTEN ONE 90 DEGREE SWIVEL MACROLINE ELBOW INTO BOTTOM OF 202022.

TRIGGER AND GRIP ASSEMBLY

PAGE I

993024

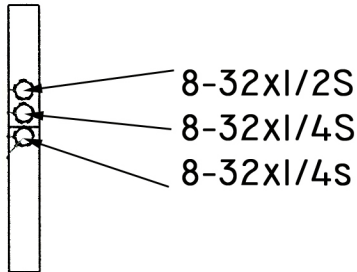

APPLY A SMALL DAB OF BLUE LOCTITE TO EACH SCREW. SCREW THE 8-32X1/2 SET SCREW IN FROM FRONT UNTIL IT JUST BARELY POKES OUT THE BACK. SCREW THE MIDDLE 8-32X1/4 SET SCREW IN FROM THE FRONT UNTIL FLUSH. SCREW THE BOTTOM 8-32X1/4 SET SCREW IN UNTIL ABOUT FLUSH IN THE BACK OF THE TRIGGER 993024.

993024

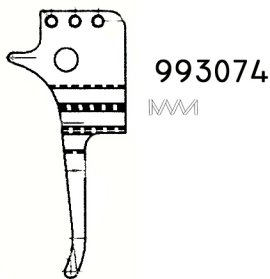

993074

MM



MICROSWITCH

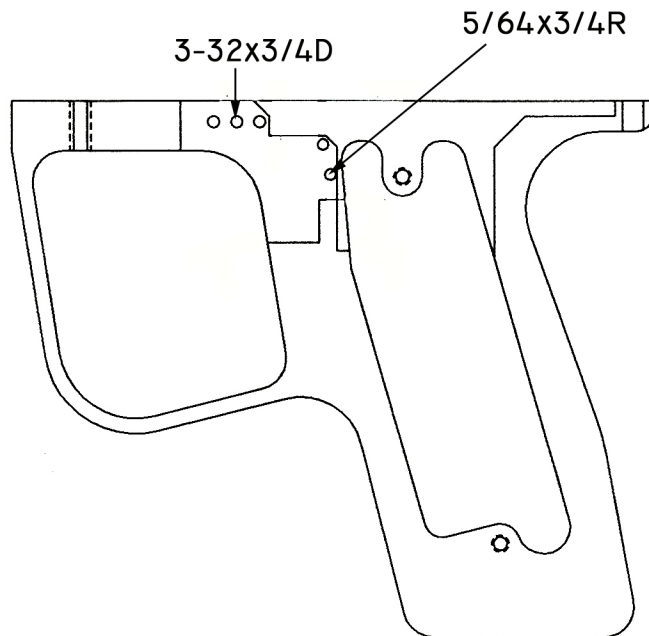

PLACE TRIGGER SPRING 993074 IN MIDDLE HOLE OF TRIGGER 993024 HOLES, IN THE BACK BEHIND THE SCREW. SLIDE TRIGGER INTO GRIP FRAME 993045. LINE UP HOLES ON TOP OF TRIGGER 993024 WITH HOLES ON TOP OF GRIP FRAME 993045. SCREW TWO 8-32X1/4 SET SCREWS INTO THREADED HOLES ON TOP SIDE OF TRIGGER FRAME THREE HOLES, SO THAT THEY HOLD THE DOWEL PIN IN PLACE. USING A GUIDE PIN, HOLD MIDDLE HOLES IN ALIGNMENT. PRESS 3-32X3/4 DOWEL PIN INTO CENTER HOLE OF GRIP FRAME 993045, AND THROUGH TRIGGER HOLE.

NEXT, PUT WIRING HARNESS IN GRIP BY PLACING MICROSWITCH BEHIND TRIGGER WITH THE LEVER PART FACING DOWN AND TOWARDS THE TRIGGER. USE GUIDE PINS TO HOLD THE MICROSWITCH HOLES AND GRIP FRAME HOLES IN ALIGNMENT. PRESS 5/64X3/4 ROLL PINS INTO THE HOLES.

TRIGGER AND GRIP ASSEMBLY

PAGE 2

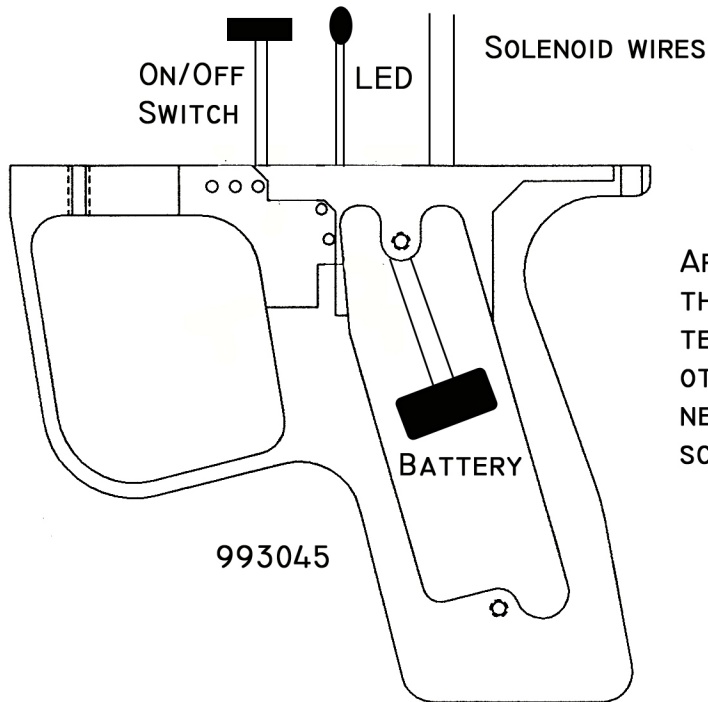

ARRANGE THE WIRING HARNESS WIRES SO THAT THE BATTERY CONNECTION AND BOARD TERMINAL REST INSIDE THE GRIP AND ALL OTHERS FACE UP OUTSIDE THE GRIP. IF NECESSARY, THREAD THE ON/OFF SWITCH SCREW HOLES WITH A 3-48 TAP.

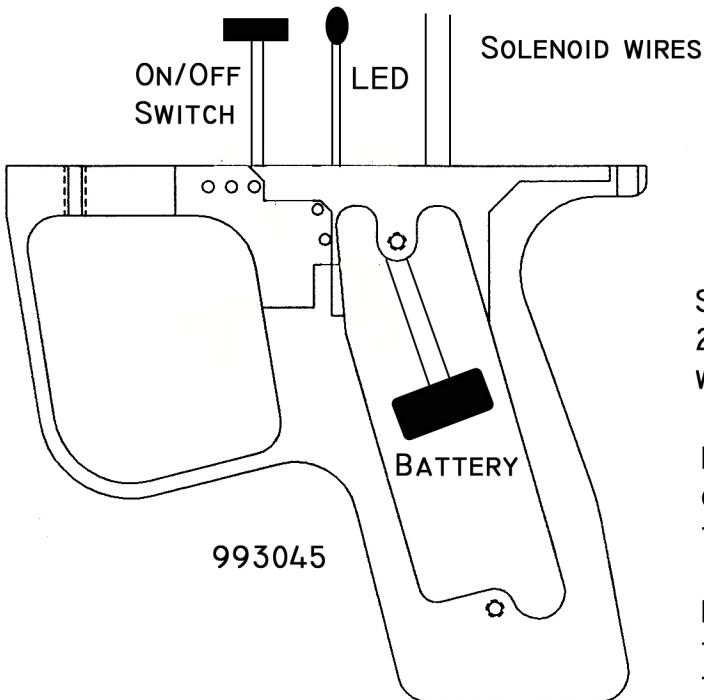

982030 OR 202030

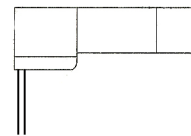

SOLDER SOLENOID 982030PK OR 202030PK TO THE SOLENOID WIRES ON THE WIRING HARNESS.

FOR B2K: THERE IS NO ORDER FOR WHICH OF THE SOLENOID WIRES ARE SOLDERED TO THE SOLENOID.

FOR BKO: THE BLACK WIRE IS SOLDERED TO THE WIRE EXTENDING FROM PIN #1. THE GREEN WIRE IS SOLDERED TO THE WIRE EXTENDING FROM PIN #2 ON THE WIRING HARNESS.

TRIGGER AND GRIP ASSEMBLY

PAGE 3

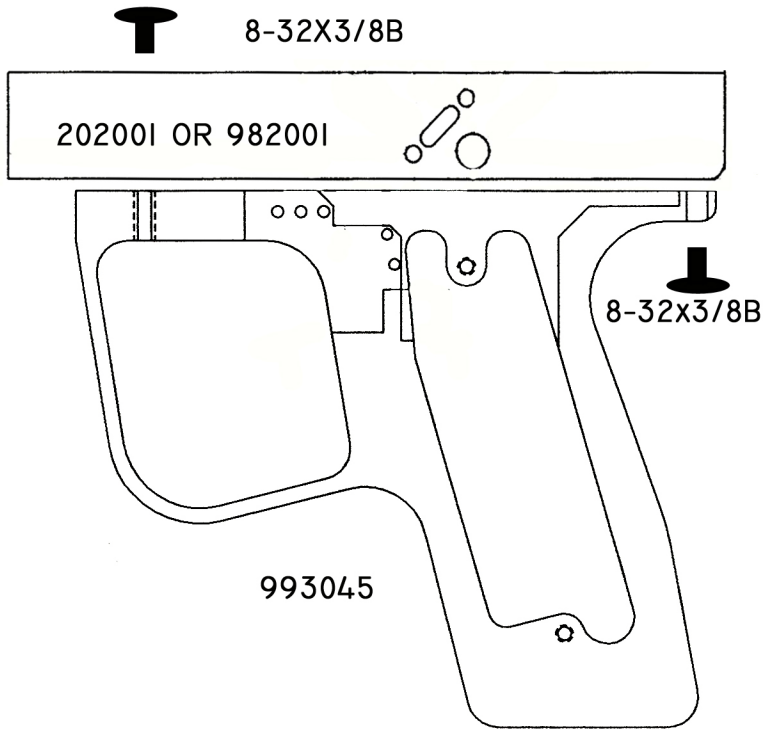

PULL THE WIRES THROUGH THE CENTER OF THE TRAY 982001 OR 202001 AND THEN SCREW THE TRAY TO THE GRIP FRAME 993045 WITH TWO 8-32X3/8 BUTTONHEAD SCREWS. MAKE SURE SCREWS ARE TIGHT. THEN INSTALL THE LED INTO THE TRAY BY PUTTING THE BLACK COVER ON THE OUTSIDE AND PUSHING THE LED THROUGH THE BACK TO BE PINNED BY THE BLACK COVER. USING TWO 3-48X3/16 PAN HEAD PHILLIPS MACHINE SCREWS, INSTALL THE ON/OFF SWITCH. LEAVE THE SOLENOID LAYING IN THE TRAY UNTIL TIME TO SCREW IT TO THE MANIFOLD.

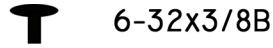
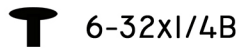
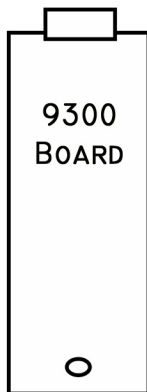

PLUG BOARD INTO WIRING HARNESS FROM BACK SIDE OF GRIP FRAME 993045, MAKING SURE THAT IT IS NOT PLUGGED IN BACKWARDS. PUT THE RIGHT GRIP PANEL ON AND SCREW THE 6-32X1/4 BUTTONHEAD SCREW IN THE TOP, AND A 6-32X3/8 BUTTONHEAD SCREW IN THE BOTTOM, GOING THROUGH THE PANEL AND THE SMALL HOLE AT THE BOTTOM OF THE BOARD. THIS SECURES AND GROUNDS THE BOARD.

NOTE: PIN #7 IS REMOVED ON THE BOARD AND PIN HOLE #7 ON CONNECTOR HAS A PLUG INSERTED. THESE MUST MATCH UP OR THE BOARD IS INSTALLED BACKWARDS.

FINAL ASSEMBLY OF BKO UPPER AND LOWER RECEIVER

STICK GASKET SCREWS THROUGH HOLES ON SOLENOID 202030PK AND THEN SET GASKET ON TOP OF SOLENOID, THROUGH SCREWS, AND MAKING SURE THAT ALL HOLES MATCH UP PROPERLY. LINE UP SCREWS WITH THREADED HOLES ON MANIFOLD, WHICH IS AT THE BASE OF THE CYLINDER BODY 202036. SCREW GASKET SCREWS IN TIGHTLY

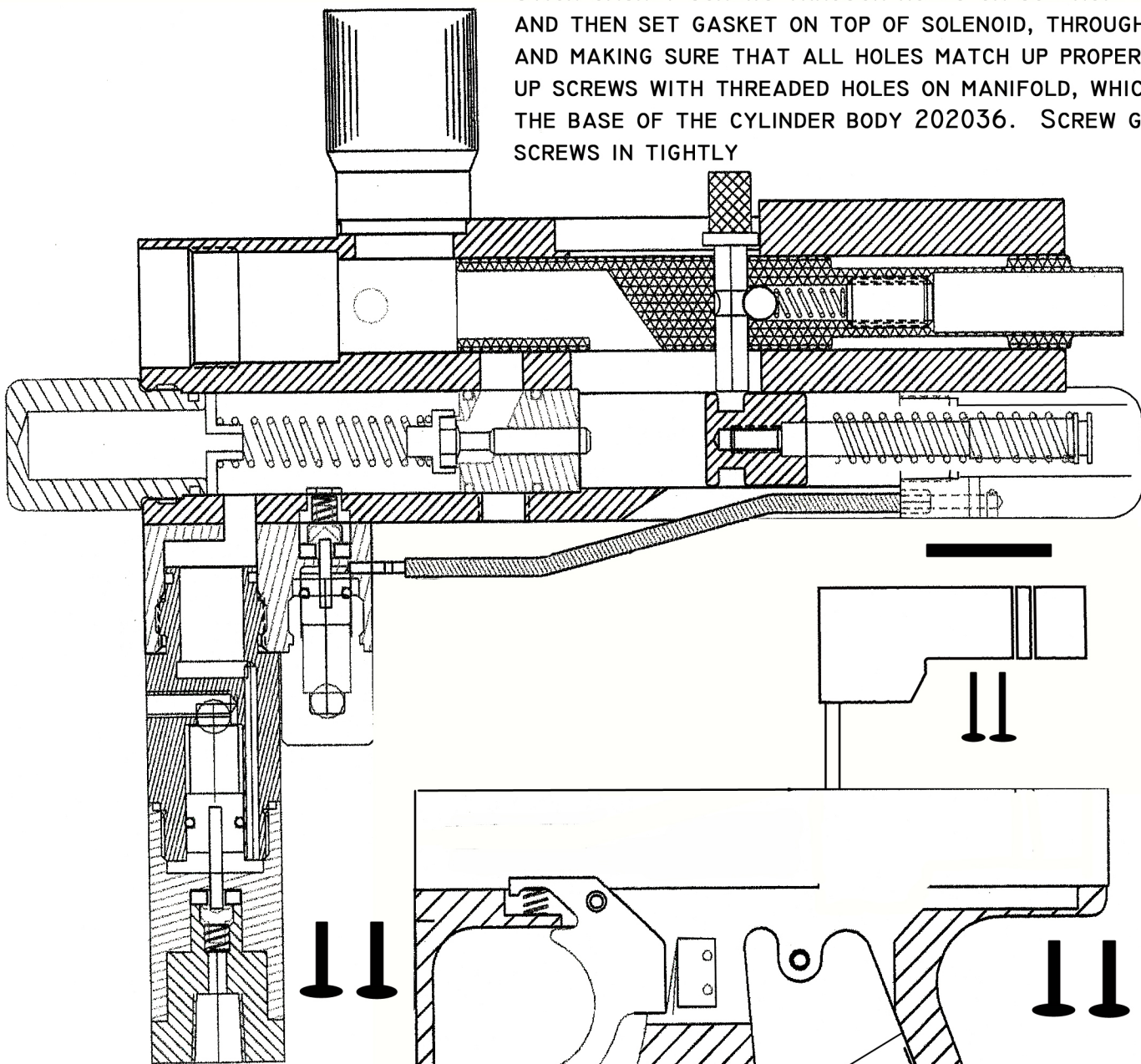

PUT UPPER AND LOWER TOGETHER, MAKING SURE THAT ALL WIRES ARE NOT PINCHED AND ARE SECURE. THERE SHOULD BE NO WIRES BETWEEN THE MICROSWITCH AND SOLENOID WHEN PUT TOGETHER. SCREW IN THE FOUR 6-32X3/4 SOCKET CAP SCREWS. AFTER TESTING, THE FRONT GRIP PANEL CAN BE PUT ON WITH TWO 6-32X1/4 BUTTONHEAD SCREWS.

Testing Instructions:

Screw in barrel 202010 and make sure the barrel threads in smoothly. Connect battery to the battery terminal inside grip. Air up marker with regulated 850 p.s.i. compressed air or nitrogen. Set high pressure regulator to 225 p.s.i. by screwing in adjustment screw on side of regulator. Turn on marker. Adjust low pressure regulator to about 90 p.s.i. by screwing in adjustment screw until you hear a small leak from the back of the marker and then unscrewing it ½ turn. Shoot a batch of paint and continue to adjust low pressure regulator until the marker shoots at about 280 fps. Continue shooting and notice any irregularities in regulated pressure or velocity. If there are any irregularities, the marker is not good. Check for leaks around all seals and listen down feed tube while not shooting for any valve leaks. Listen in the back of marker while not shooting for any solenoid leaks. If there are any leaks, marker is not good. Verify that all screws and parts are screwed on tight. Make minor adjustments to trigger screws if necessary for contacting microswitch. Shoot marker fast and watch bolt to make sure it springs back properly and keeps up with the speed of marker. Watch regulator and ensure that it is recovering fast enough. Rest marker for a period and then begin shooting again. Verify that the regulators do not climb or drop in pressure. If they do, marker is not good. Turn off air supply. Wait for a period and then turn air supply back on. Make sure regulators climb back to previous set pressures and that they do not climb or drop in pressure. Recheck for leaks and shoot again. If it the marker is satisfactory, turn off air supply and power source. Disconnect battery and attach left side panel. Clean entire outside of marker and inspect for satisfactory finish. Unscrew barrel and package marker with barrel, manual, and a kit containing the additional 90 degree swivel ¼ inch macroline elbow, 5 inches of macroline hose, and a 5/64 and 3/32 allen wrench. Close and seal package and label accordingly.

Indian Creek Design 2004 BKO

<i>Part No.</i>	<i>Item Description</i>	<i>Qty. per marker</i>
9300	Board	1
202001	Lower Receiver/Tray	1
202020	HP Reg Upper Body	1
202021	HP Reg Middle Body	1
202022	HP Reg Cup Housing	1
202033	Cylinder Piston	1
202036	Cylinder Body	1
202037	Cylinder End Cap	1
202052	HP Regulator Piston	1
202071	BKO Main Spring	1
203010	Barrel	1
302030	Valve Seal	1
935075	Regulator Cup Spring	2
952032	Regulator Seal	2
952076	HP Main Spring	2
964073	Bolt Retention Spring	1
982006	Feed Tube	1
982009	Bolt	1
982028	Valve Cup	1
982029	Valve Pin	1
982030	Valve Seat	1
982032	Hammer	1
982041	Link Pin	1
982052	Regulator Cup	2
982053	LP Regulator Piston	1
982054	LP Regulator Body	1
982055	LP Cup Housing, original	1
982056	LP Adjustment Screw	1
982073	B2K old Valve Spring	1
992006	Ball Detent	1
993024	Trigger	1
993045	Grip Frame	1
993074	Trigger Spring	1
10-32x1/2B	10-32x1/2 Buttonhead	2
10-32x3/4S	10-32x3/4 Socket Head Cap Screw	2
10-32x3/8C	10-32x3/8 Cone Point Set Screw	1
10-32x3/8S	10-32x3/8 Set Screw	1

202002B or 204002	Regulator Mount Rev. B	1
202003B or 204003	Upper Receiver Rev. B	1
202030PK	Three way solenoid valve	1
202030PKG	Solenoid Gasket	1
3/8-24x1/4S	3/8-24x1/4 Set Screw	1
3-32x3/4D	3-32x3/4 Dowel Pin	2
3-32x5/8D	3-32X5/8 Dowel Pin	1
3-48x3/16P	3-48x3/16 Pan Head Phillips Machine Screw	2
5/16-24x1/2S	5/16-24x1/2 Set Screw	1
5/64x3/4R	5/64x3/4 Roll Pin	2
6-32x1/4B	6-32x1/4 Buttonhead	4
6-32x3/4S	6-32x3/4 Socket Head Cap Screw	4
6-32x3/8B	6-32x3/8 Buttonhead	1
8-32x1/2S	8-32x1/2 Set Screw	1
8-32x1/4S	8-32x1/4 Set Screw	2
8-32x3/8B	8-32x3/8 Buttonhead	2
D1/4MACRO90SW	1/4" Macroline fitting, 90 Swivel	2
D1/4MACROHOSE	1/4" Macroline Hose	1
D250HCB	1/4 Chrome ball bearing	2
D700LPG	700 p.s.i. Gauge	1
DGRIP-SL	Left Grip Panel	1
DGRIP-SR	Right Grip Panel	1
H-006	H-006 O-Ring	1
H-010	H-010 BN70 O-Ring	1
H-010UR	H-010 UR90 O-Ring	2
H-011	H-011 BN70 O-Ring	1
H-012	H-012 BN70 O-Ring	1
H-015	H-015 BN70 O-Ring	3
H-015UR	H-015 UR90 O-Ring	2
H-016	H-016 BN70 O-Ring	3
H-019	H-019 BN70 O-Ring	2
HAR-101	Wiring Harness	1
	Hose for LP circuit	1
	10/32 Barb	2